

# Ten-8 Fire Equipment F19P-1930

Type I - MXP153E - Ford F450

**Sale sheet:** F19P-1930\_DEMERS DEMO\_MXP153E-FORD-V19.03

**Date & revision:** 2020-04-22 rev.0

General exterior .....	page 2	Floor view .....	page 10
Curbside exterior .....	page 3	Ceiling view .....	page 11
Streetside exterior .....	page 4	Front console .....	page 12
Front & rear exterior .....	page 5	Rear consoles .....	page 13
Curbside interior wall .....	page 6	Floor console details .....	page 14
Streetside interior wall .....	page 7		
Front interior wall .....	page 8		
Rear interior wall .....	page 9		

## DISCLAIMERS

Should there be any discrepancies between the sales sheet and these drawings; the sales sheet will take precedence. These drawings are subject to change by engineering during the construction process of the vehicle. Dimensional data for information only.

I have read and agree to the terms

I have read and agree to the terms

Dealer signature : \_\_\_\_\_

Customer Signature : \_\_\_\_\_

Name : \_\_\_\_\_

Name : \_\_\_\_\_

Date : \_\_\_\_\_

Date : \_\_\_\_\_

# Ten-8 Fire Equipment F19P-1930

General exterior with custom paint

Date: 2020-04-22 rev.0  
Scale: 1:45  
Designer: BL

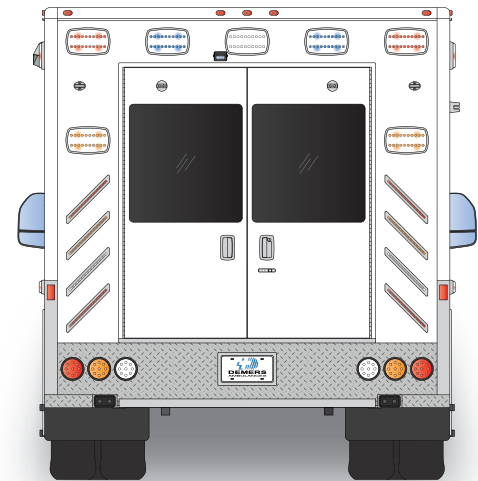
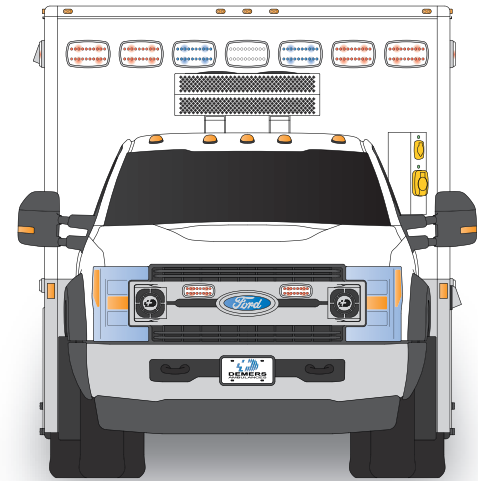

# Ten-8 Fire Equipment F19P-1930

Curbside exterior

Date: 2020-04-22 rev.0  
 Scale: 1:30  
 Designer: BL

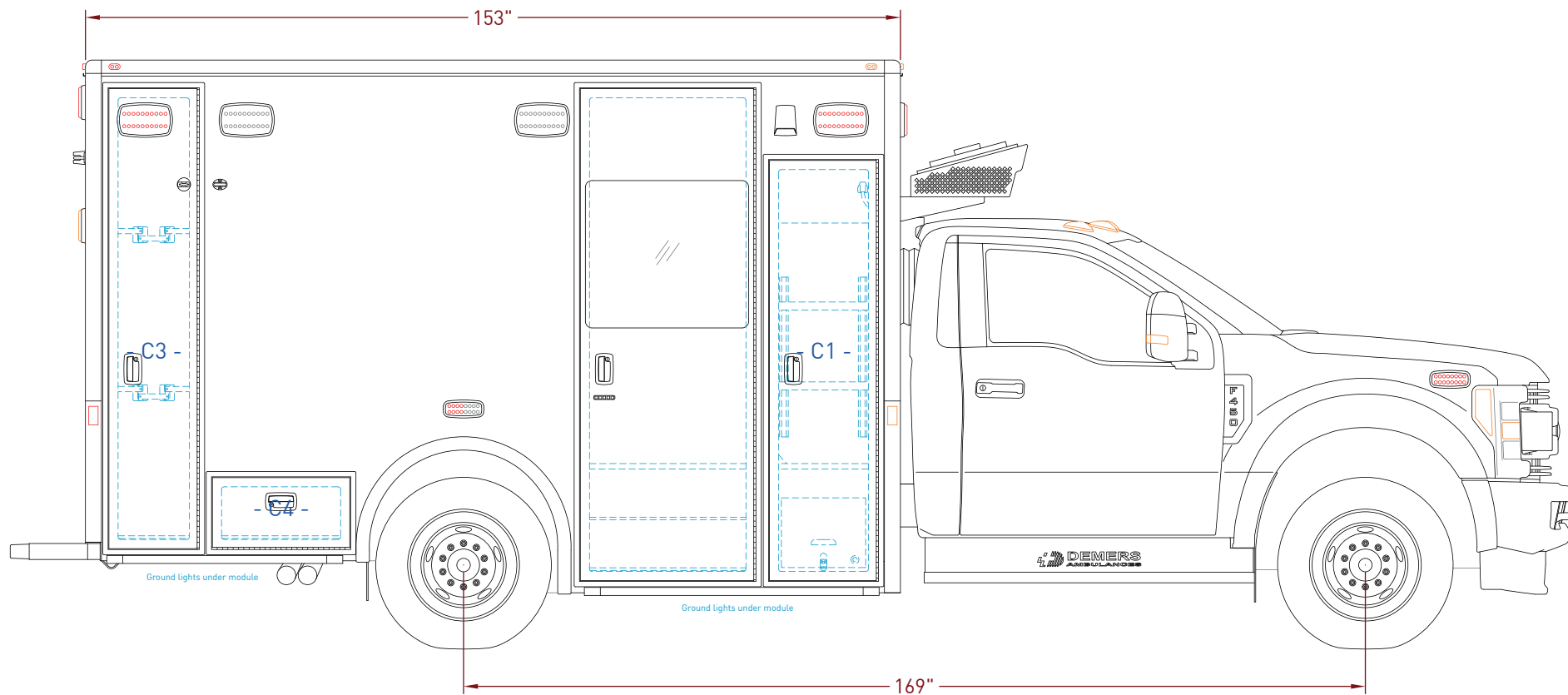

Compartment	Opening L x H	Interior dimensions L x H x D
C1	16.75" x 55.00"	19.25" x 45.25" x 31.50"
C2	29.25" x 88.75"	-
C3	13.25" x 82.75"	16.75" x 84.25" x 18.50"
C4	22.25" x 9.75"	25.00" x 11.00" x 10.75"

# Ten-8 Fire Equipment F19P-1930

Streetside exterior

Date: 2020-04-22 rev.0  
 Scale: 1:30  
 Designer: BL

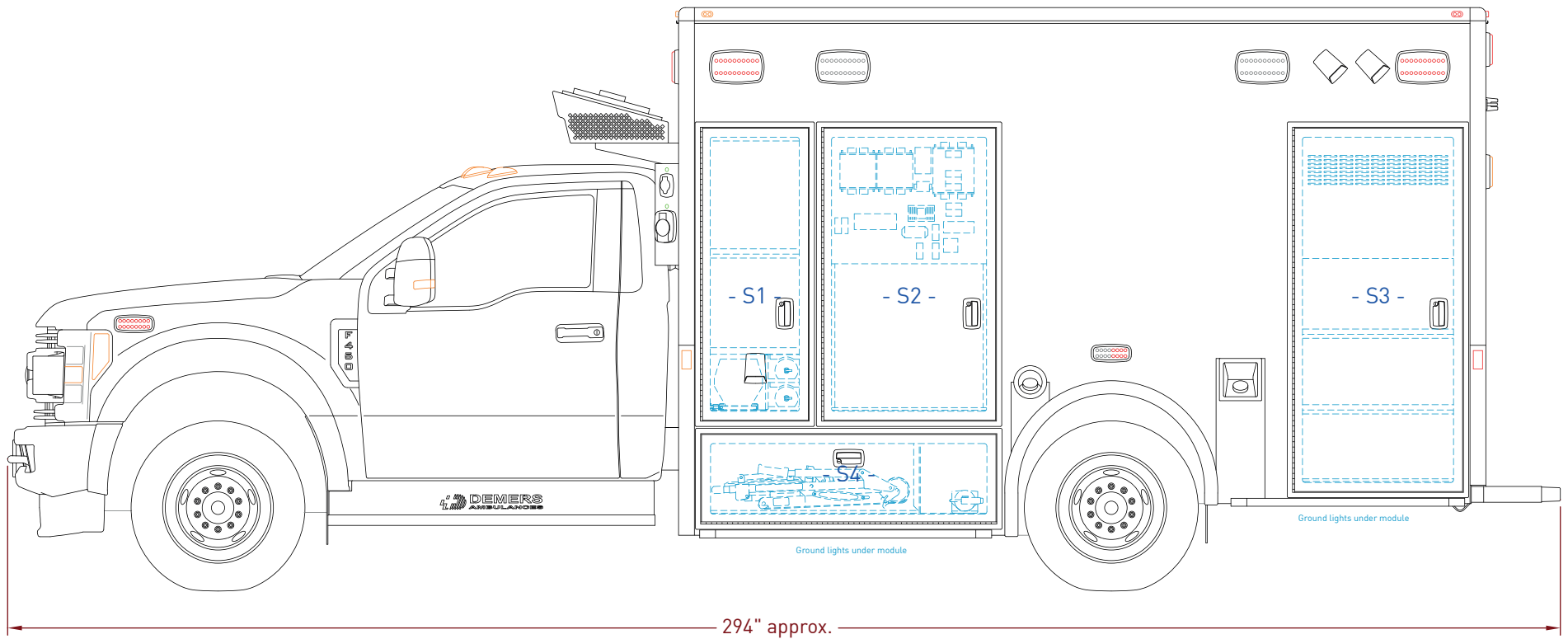

Compartment	Opening L x H	Interior dimensions L x H x D
S1	16.75" x 52.00"	20.50" x 51.00" x 18.25"
S2	29.25" x 52.00"	32.25" x 27.75" x 18.75"
S3- Std height	28.50" x 65.50"	33.25" x 42.25" x 17.50"
S4	52.25" x 13.25"	55.00" x 14.50" x 20.25"

# Ten-8 Fire Equipment F19P-1930

Front & rear exterior

Date: 2020-04-22 rev.0  
 Scale: 1:30  
 Designer: BL

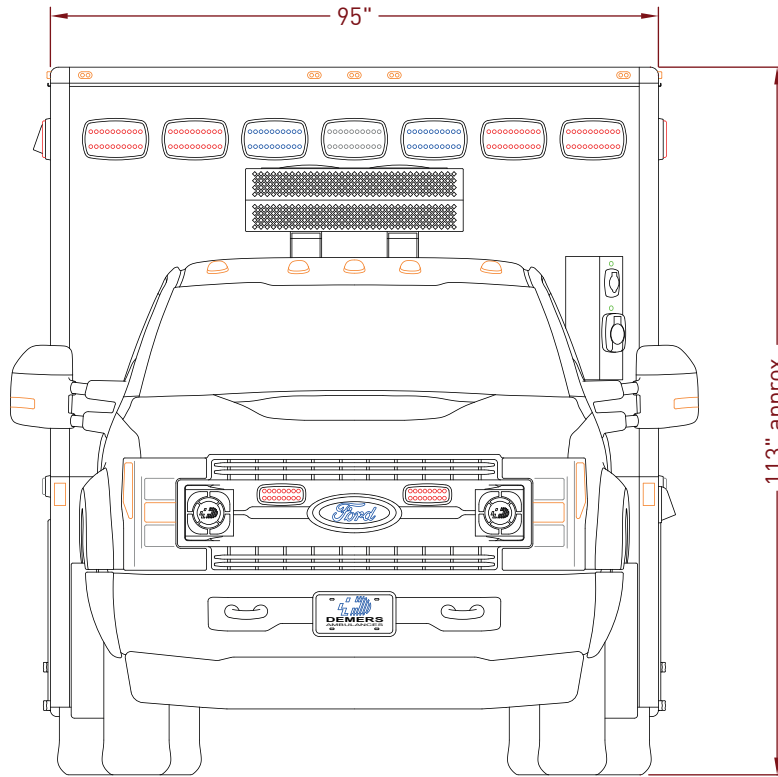

**Note**

The total height of the vehicle can be different according to chassis and suspensions

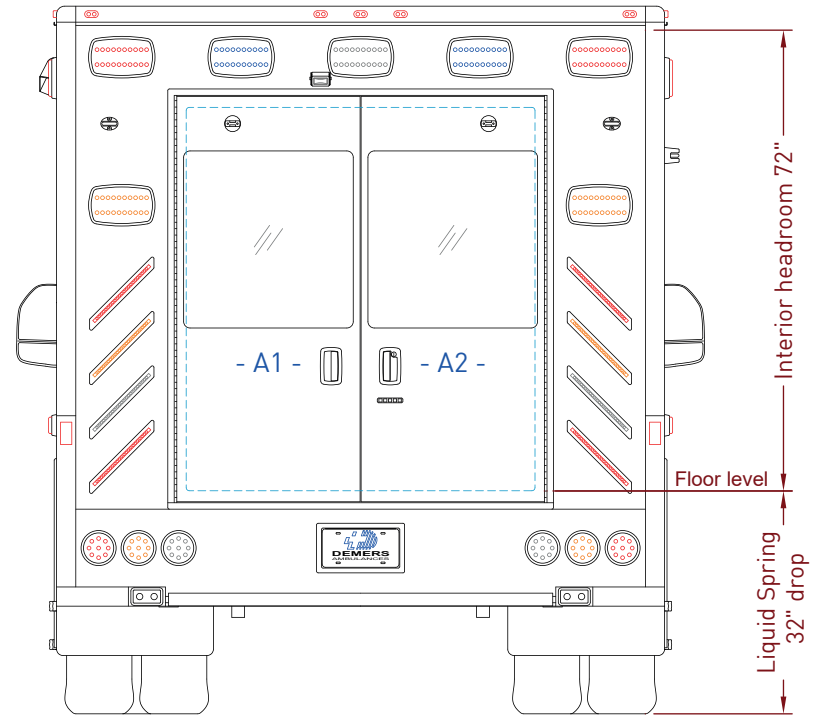

**Note**

The rear loading height of the vehicle can be different according to chassis and suspensions

Compartment	Opening L x H	Interior dimensions L x H x D
A1 & A2	54.50" x 59.75"	-

# Ten-8 Fire Equipment F19P-1930

Curbside interior wall

Date: 2020-04-22 rev.0  
 Scale: 1:20  
 Designer: BL

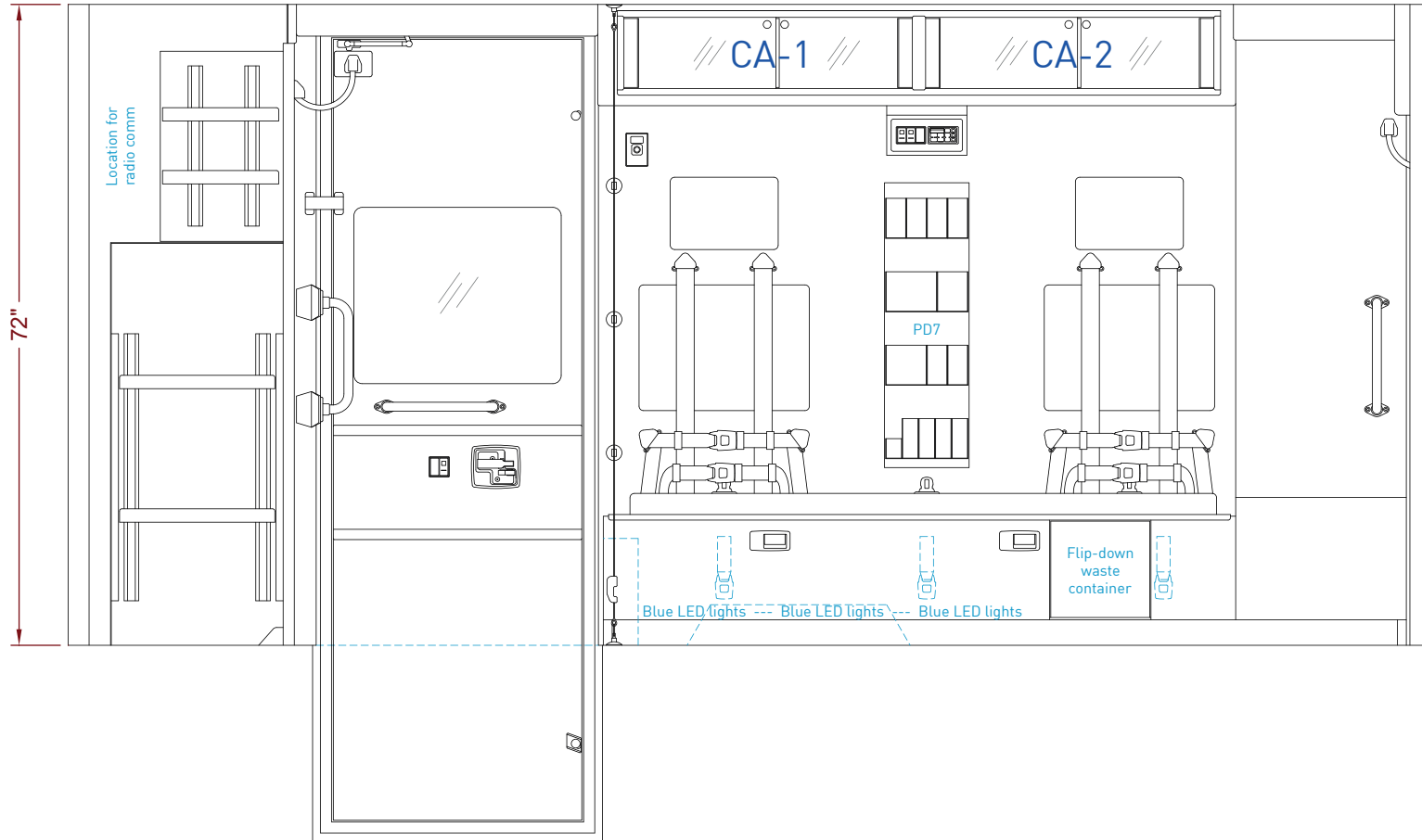

Compartment	Opening L x H	Interior dimensions L x H x D
Storage cabinet -CA-	32.50" x 8.00"	33.50" x 9.50" x 12.00"

# Ten-8 Fire Equipment F19P-1930

Streetside interior wall

Date: 2020-04-22 rev.0  
 Scale: 1:20  
 Designer: BL

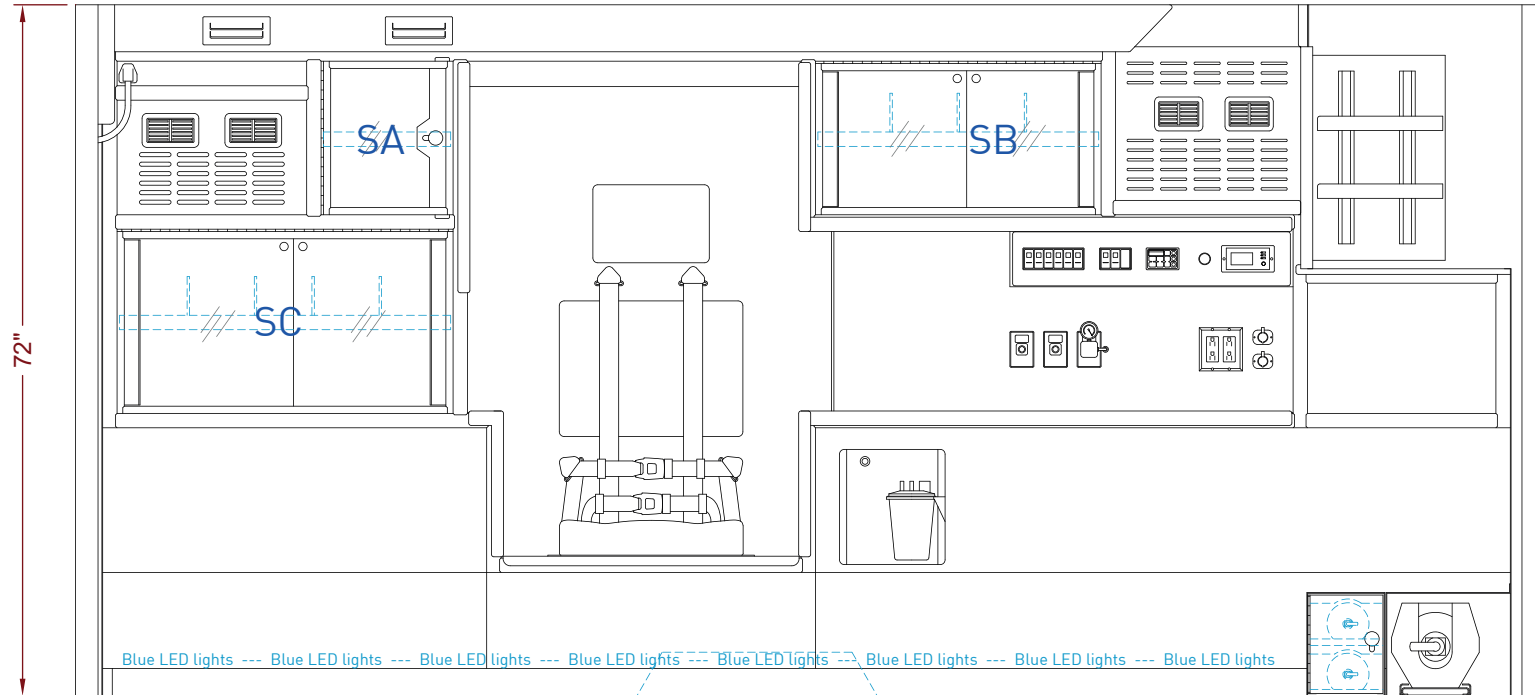

Compartment	Opening L x H	Interior dimensions L x H x D
Storage cabinet -SA-	13.75" x 16.00"	14.75" x 17.00" x 16.50"
Storage cabinet -SB-	29.75" x 16.00"	30.75" x 17.00" x 12.00"
Storage cabinet -SC-	16.00" x 19.25"	17.00" x 20.25" x 16.75"

# Ten-8 Fire Equipment F19P-1930

Front interior wall

Date: 2020-04-22 rev.0  
 Scale: 1:20  
 Designer: BL

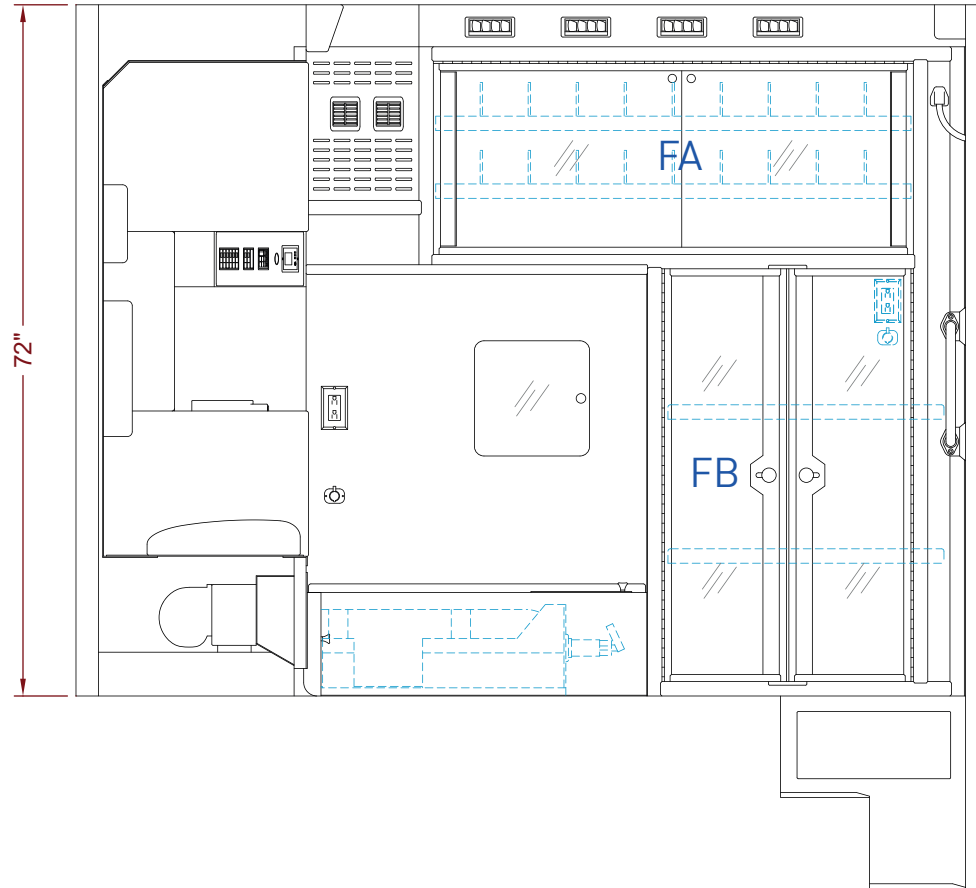

Compartment	Opening L x H	Interior dimensions L x H x D
Storage cabinet -FA-	50.00" x 20.00"	52.25" x 21.25" x 13.75"
ALS comp. -FB-	26.00" x 43.00"	31.50" x 45.25" x 19.25"



# Ten-8 Fire Equipment F19P-1930

Rear interior wall

Date: 2020-04-22 rev.0  
Scale: 1:20  
Designer: BL

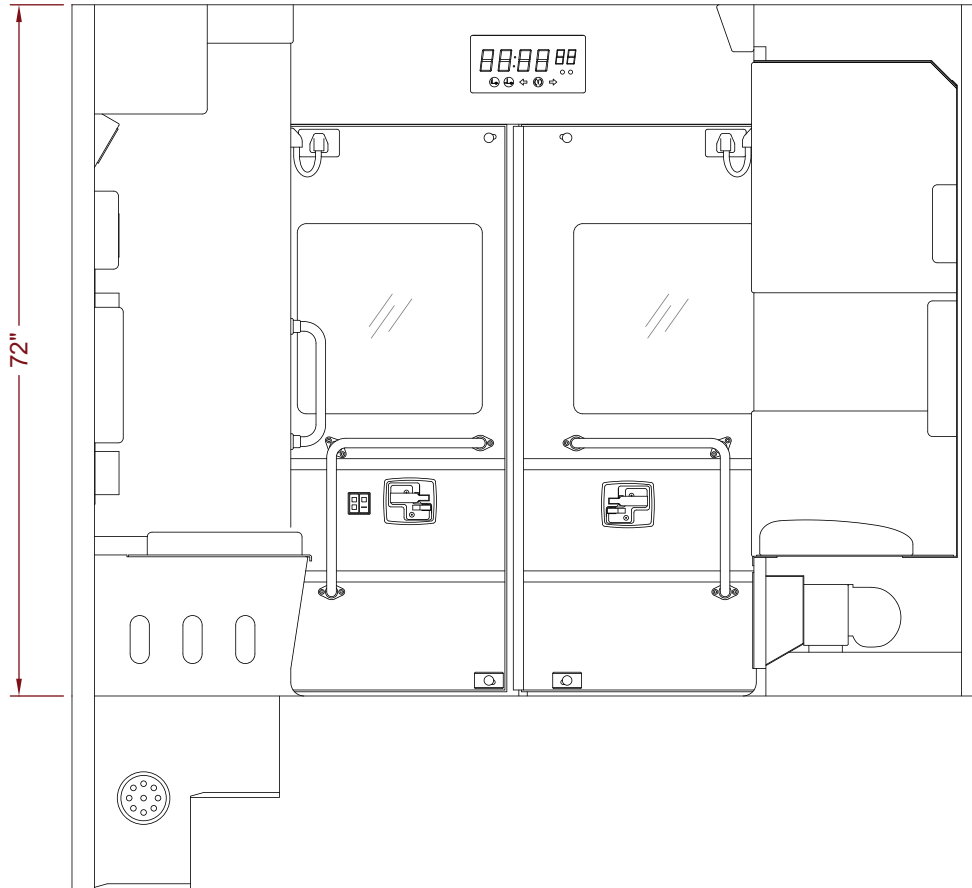

# Ten-8 Fire Equipment F19P-1930

Floor view

Date: 2020-04-22 rev.0  
Scale: 1:30  
Designer: BL

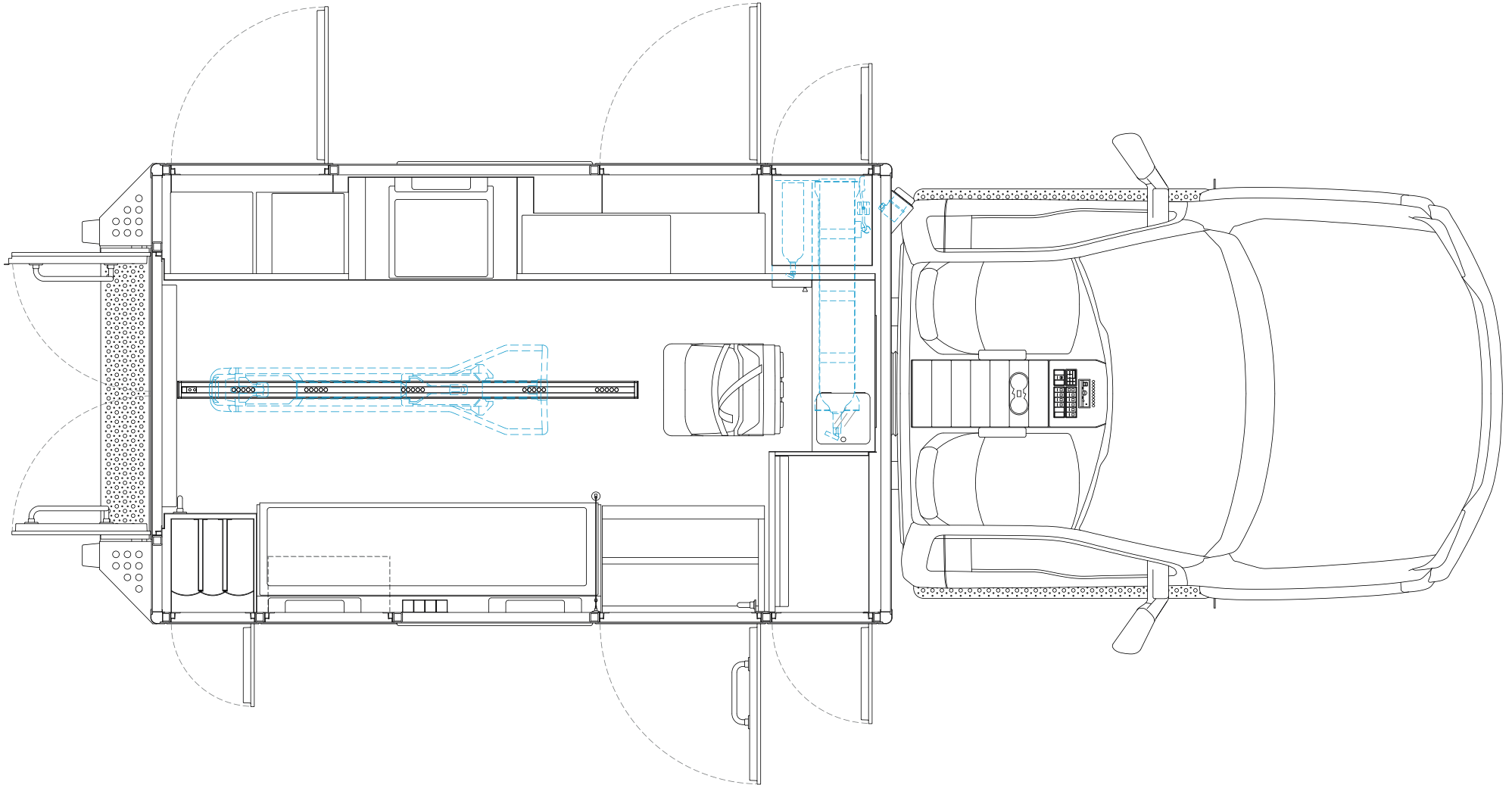

# Ten-8 Fire Equipment F19P-1930

Ceiling view

Date: 2020-04-22 rev.0  
Scale: 1:30  
Designer: BL

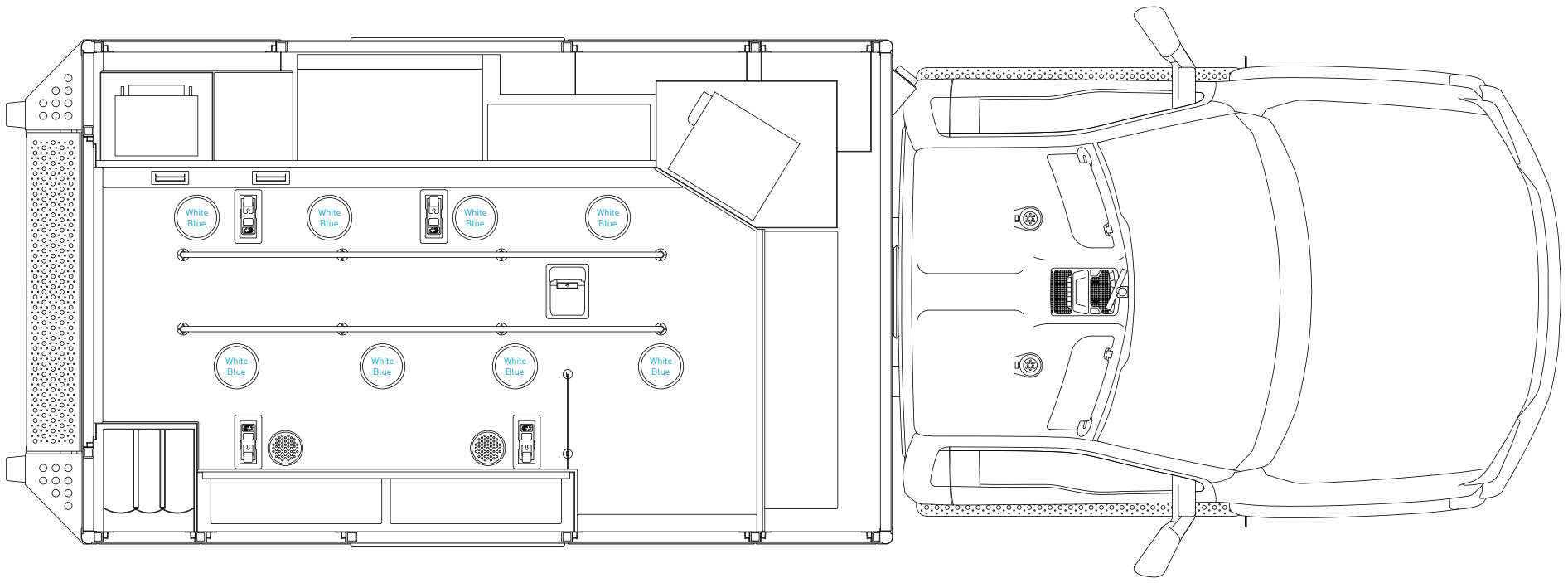

# Ten-8 Fire Equipment F19P-1930

Front console

Date: 2020-04-22 rev.0  
Scale: 1:3  
Designer: BL

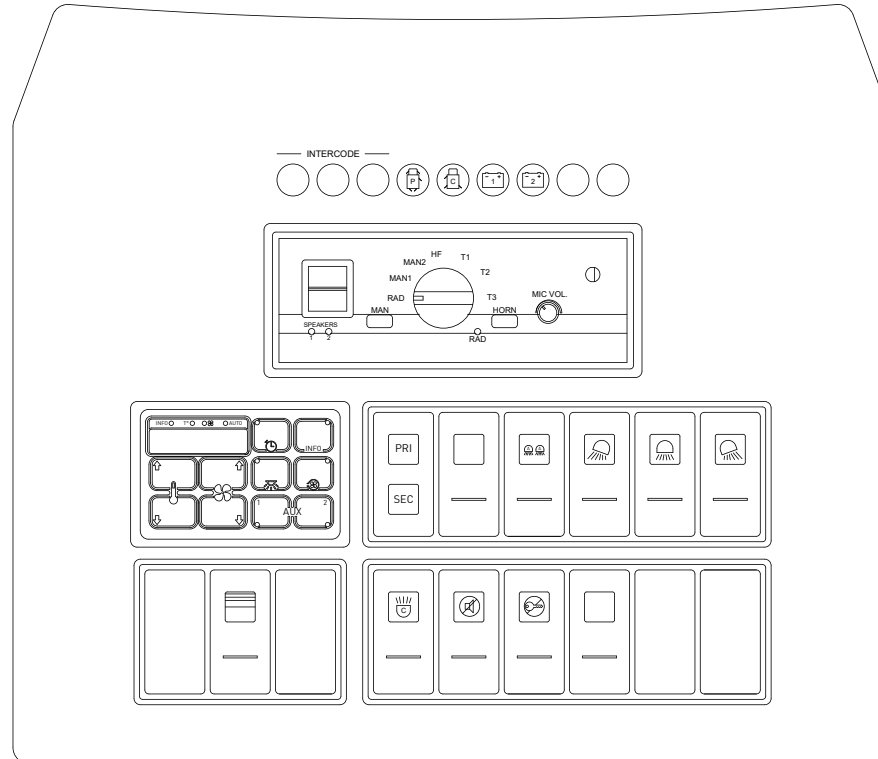

## Streetside console

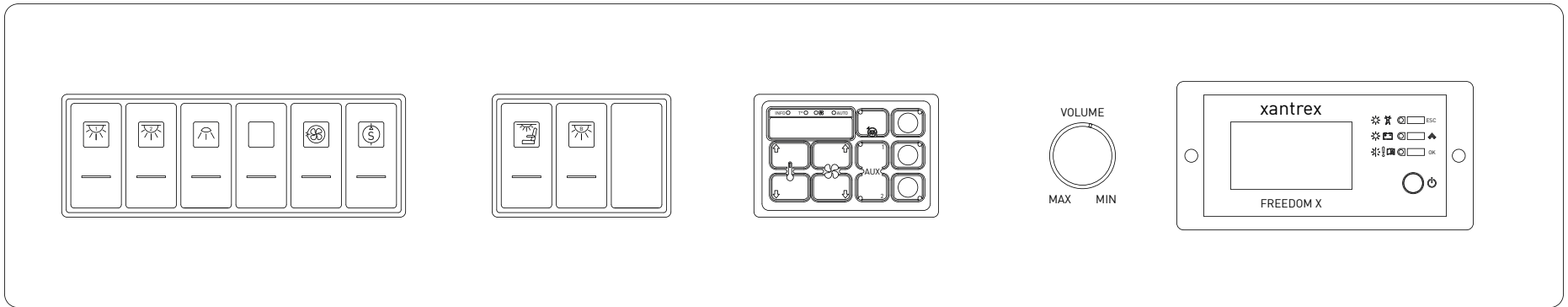

## Curbside console

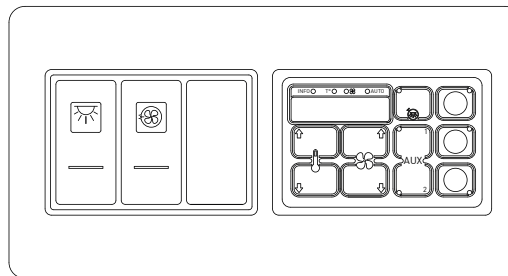

Top view

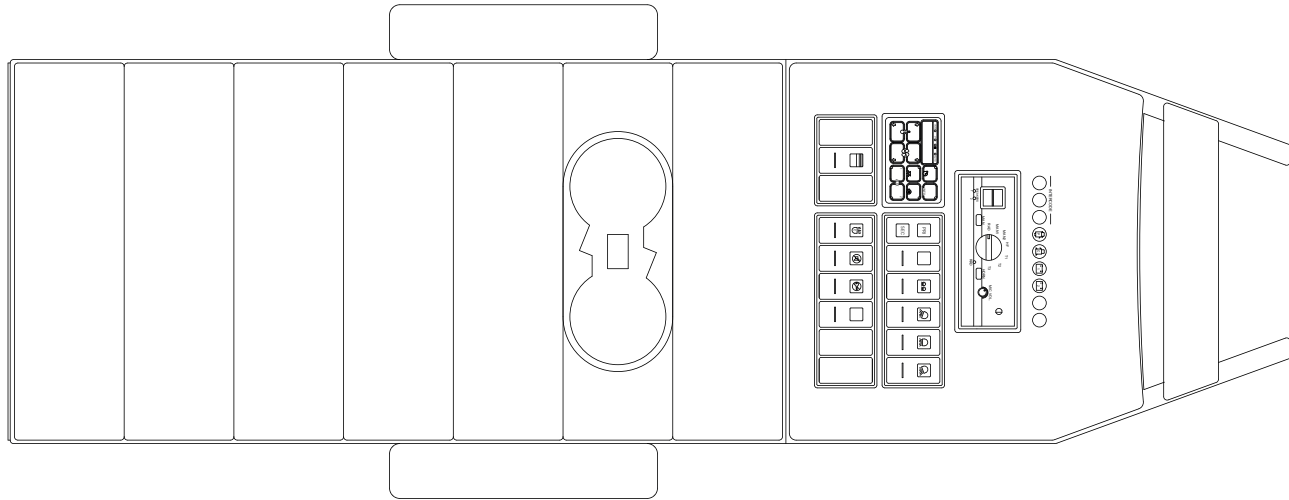

Side view

